

20.75.1201.00

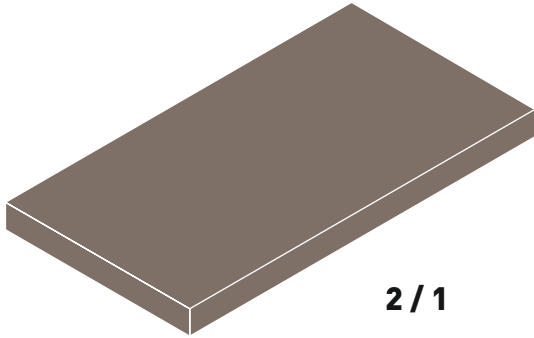

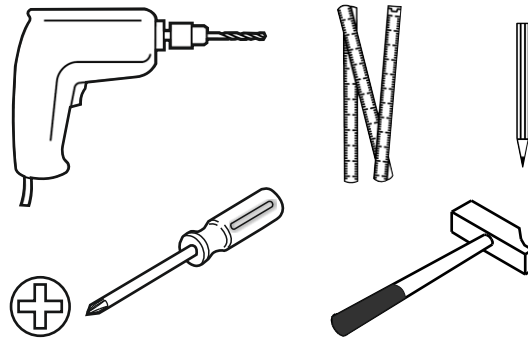

2/1

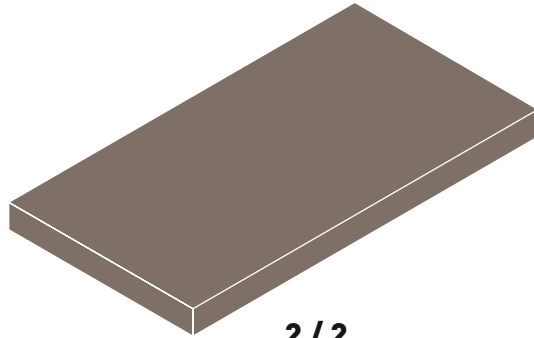

2/2

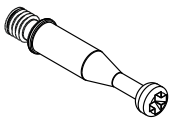

13.07.01.108 x 24



13.07.01.110 x 24

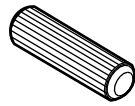

13.01.01.111 x 8

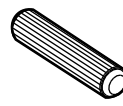

13.01.01.110 x 8



13.01.01.045 x 20



13.01.01.107 x 3



M4X22
13.03.01.010 x 3

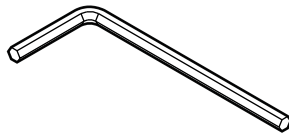

13.07.01.016 x 1

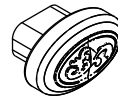

13.06.01.116 x 3

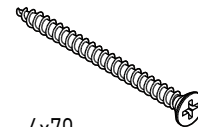

4x70
13.02.01.011 x 1

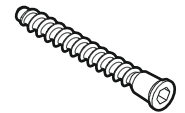

13.02.01.019 x 15

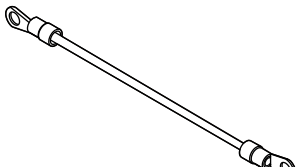

13.07.01.135 x 1



M6X13
13.03.01.021 x 1

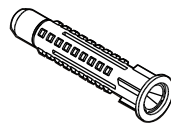

13.01.01.175 x 1

2/1

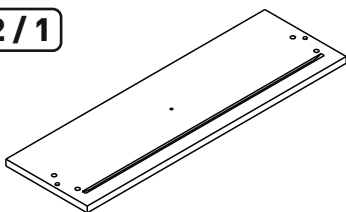

18.75.1201.012 x 1

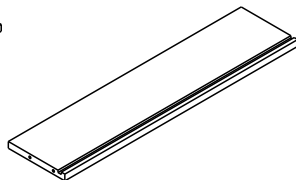

18.75.1201.013 x 1

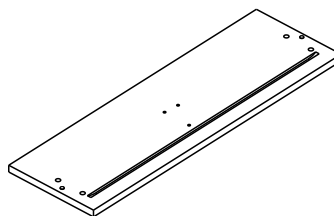

18.75.1201.005 x 2

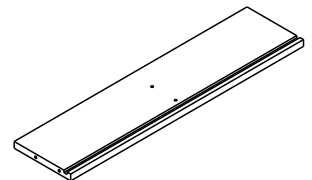

18.75.1201.008 x 2

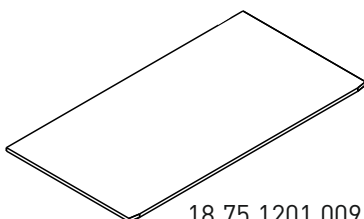

18.75.1201.009 x 3

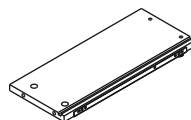

18.75.1201.007 x 3

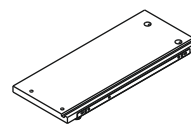

18.75.1201.006 x 3

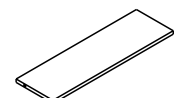

18.75.1201.014 x 2

2/2

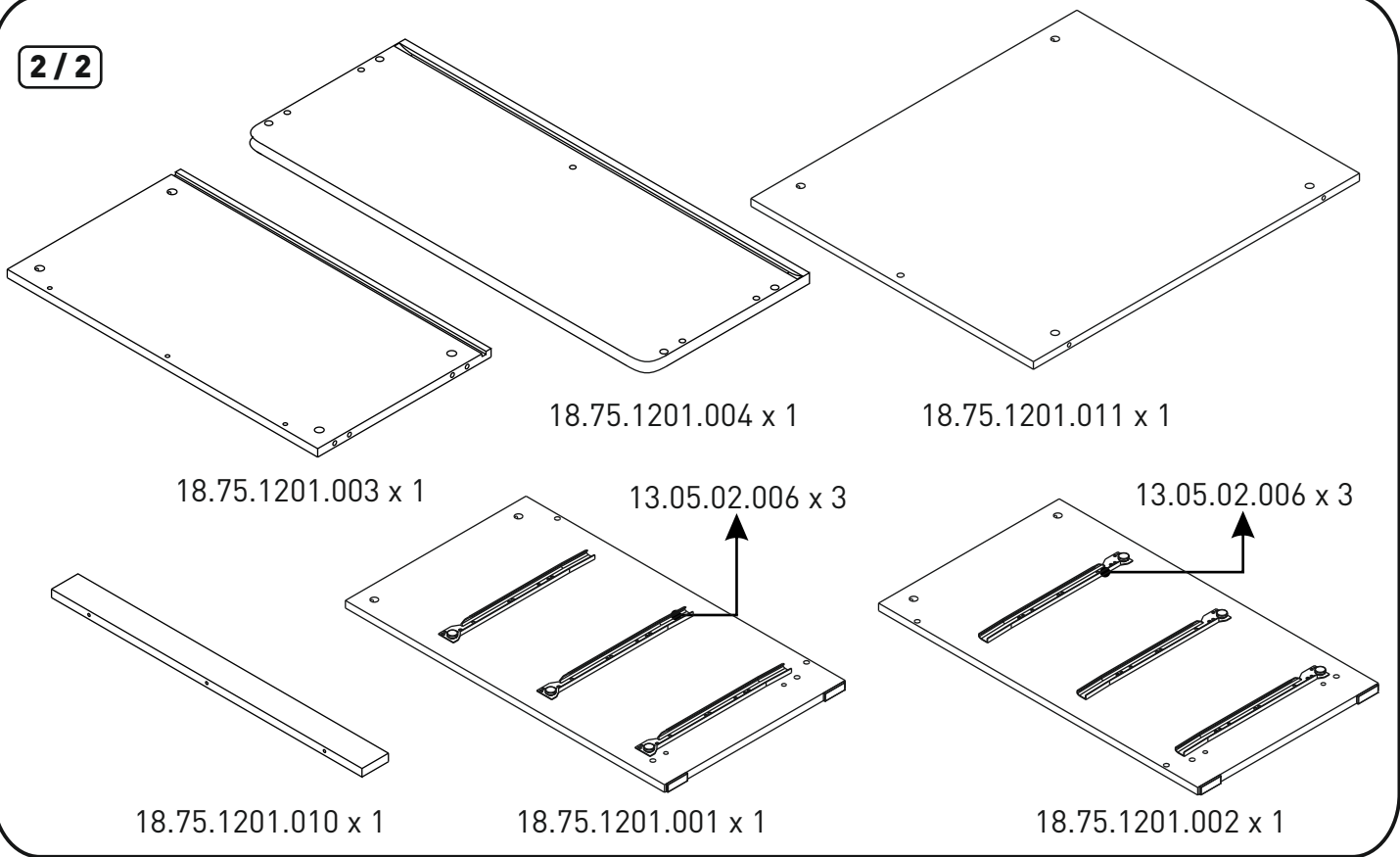

1

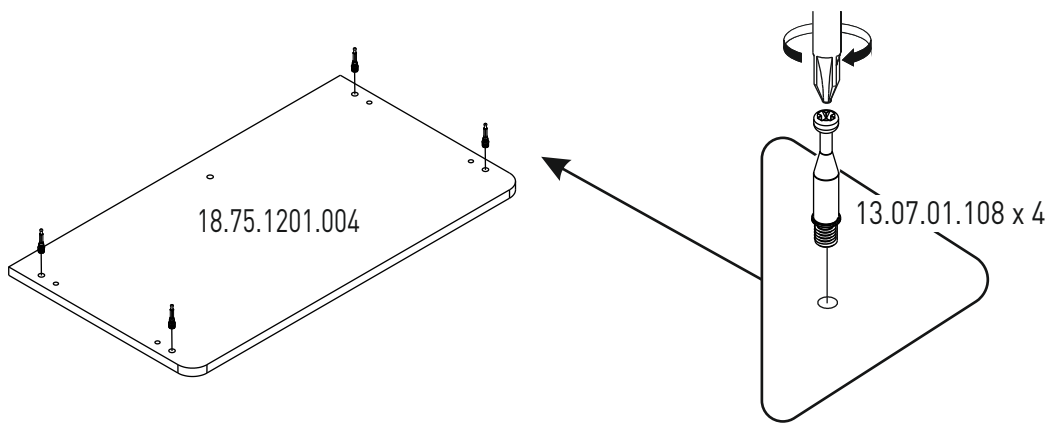

2

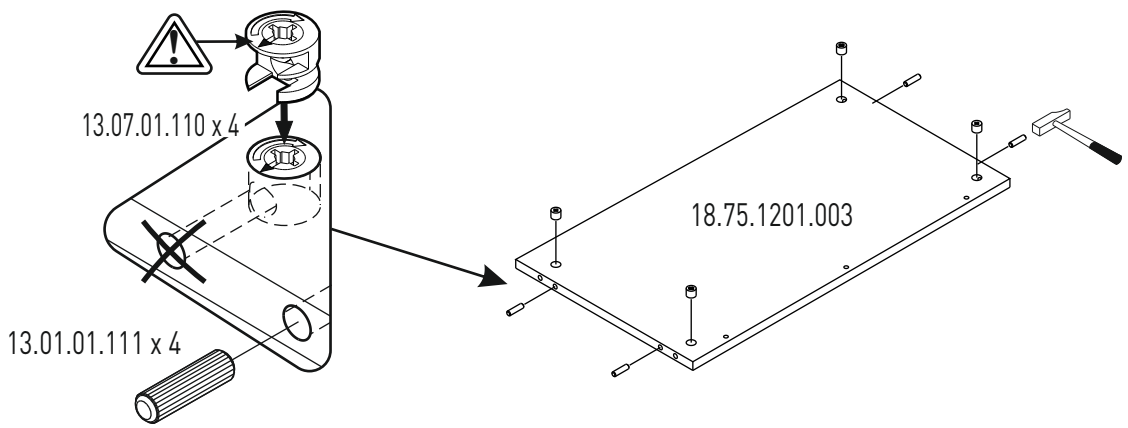

3

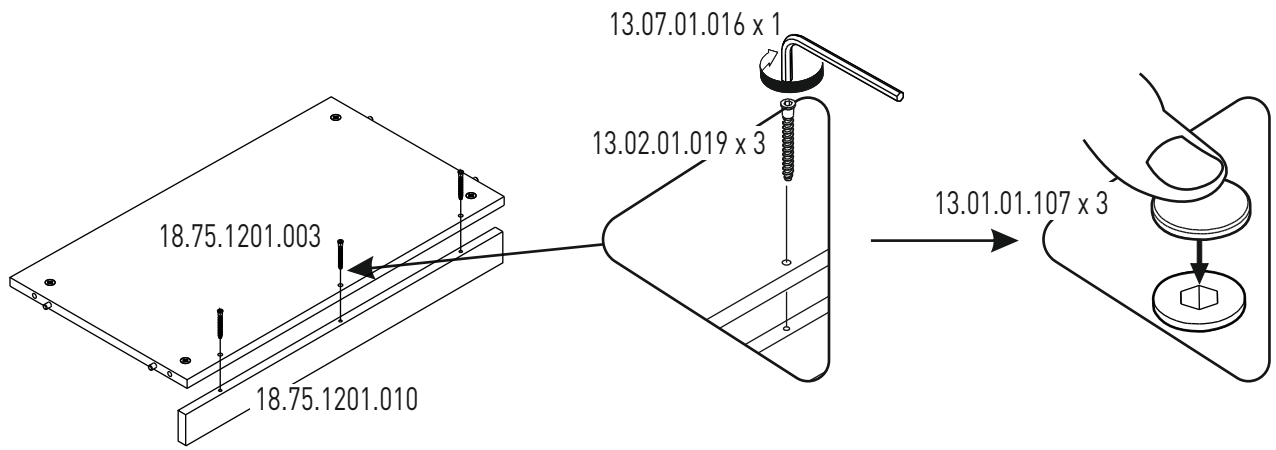

4

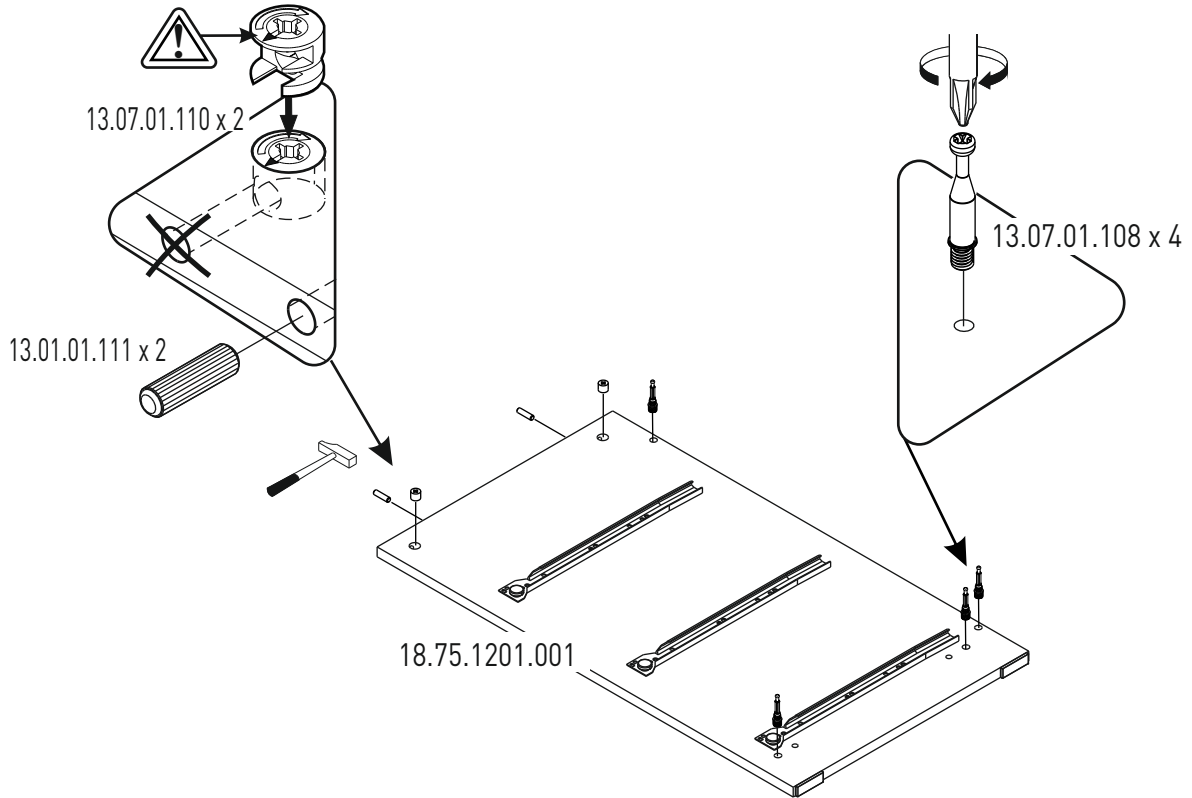

5

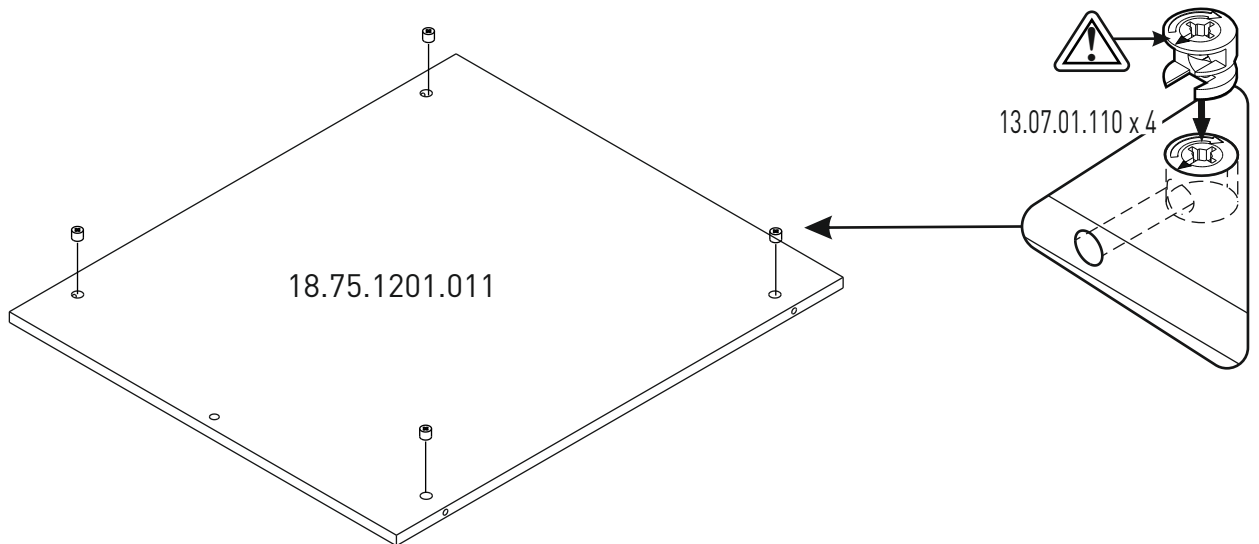

6

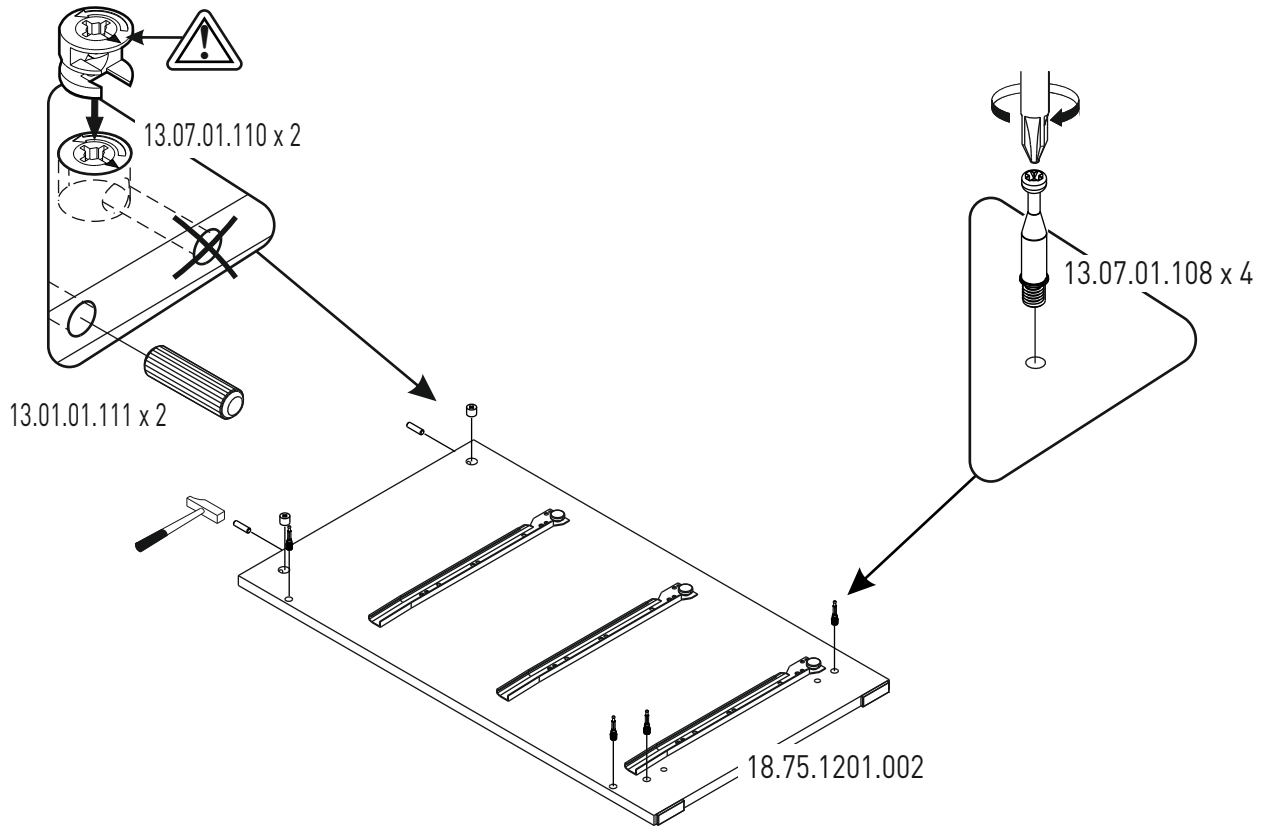

7

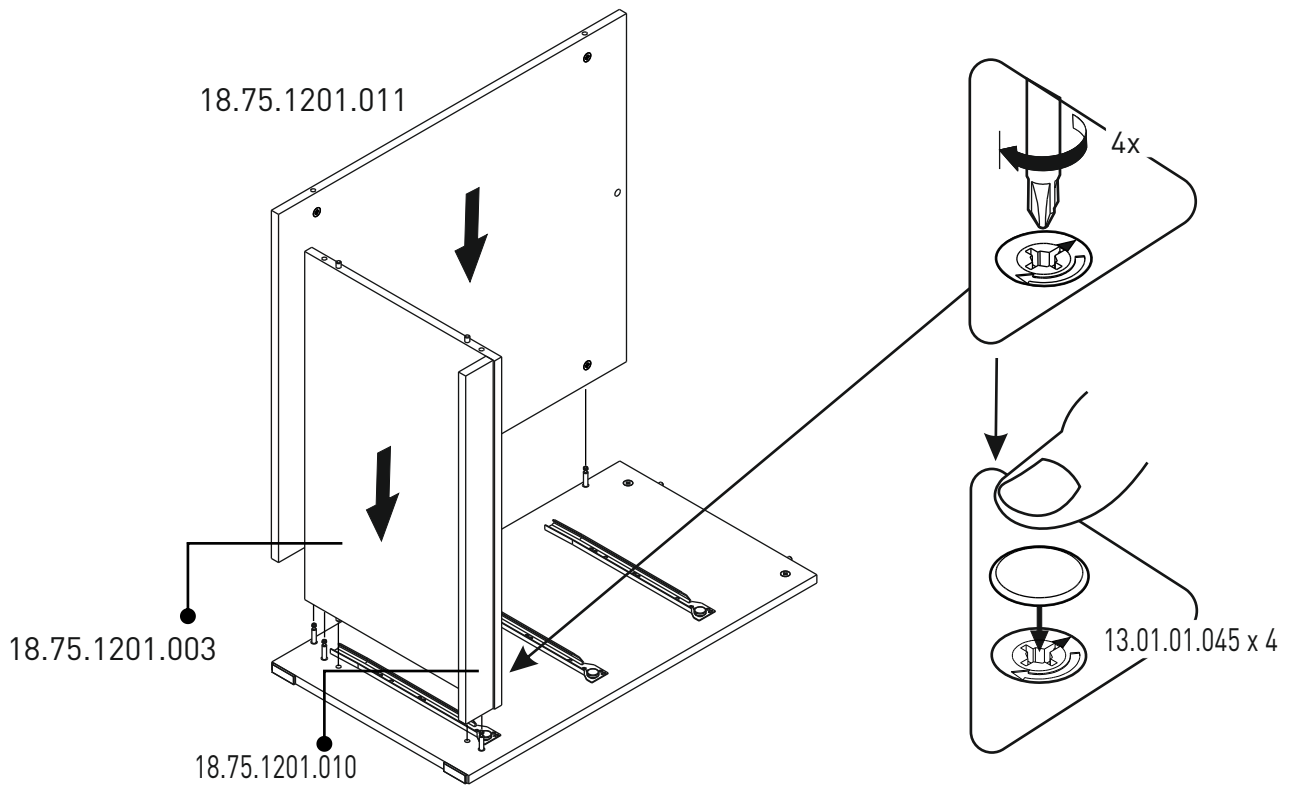

18.75.1201.002

8

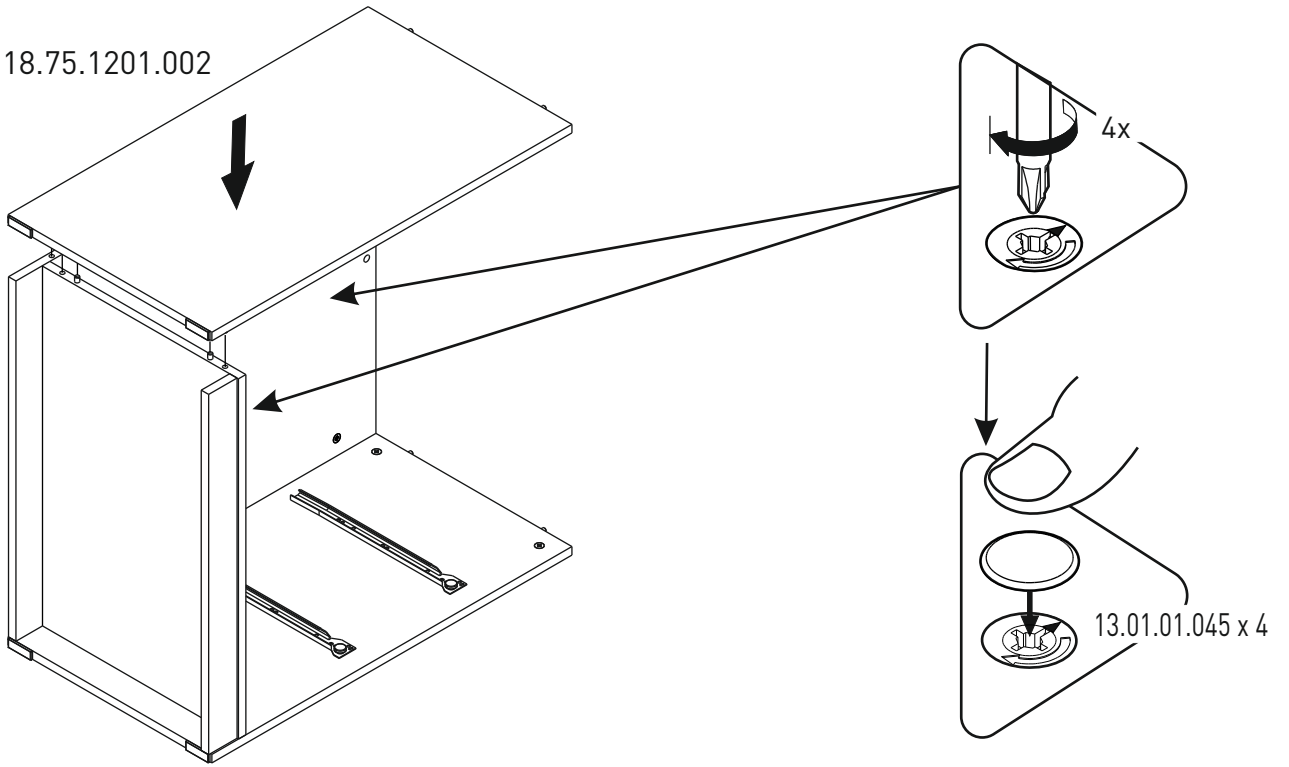

9

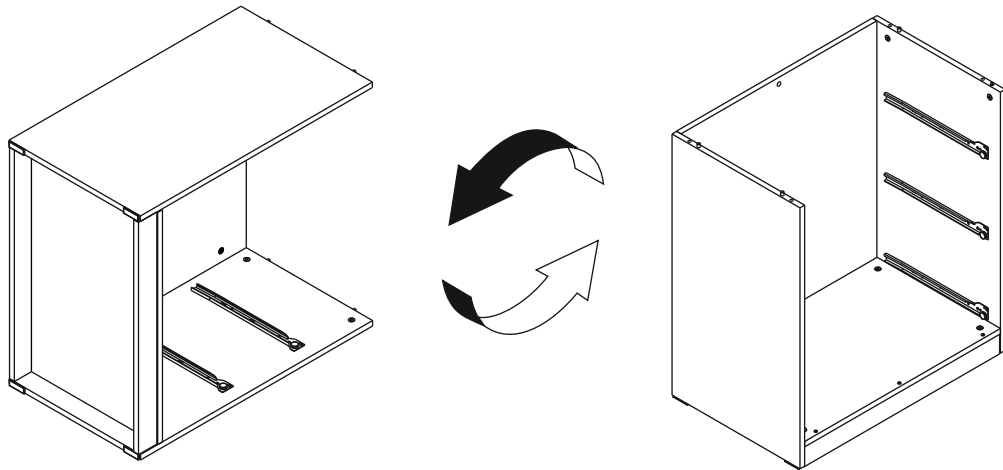

10

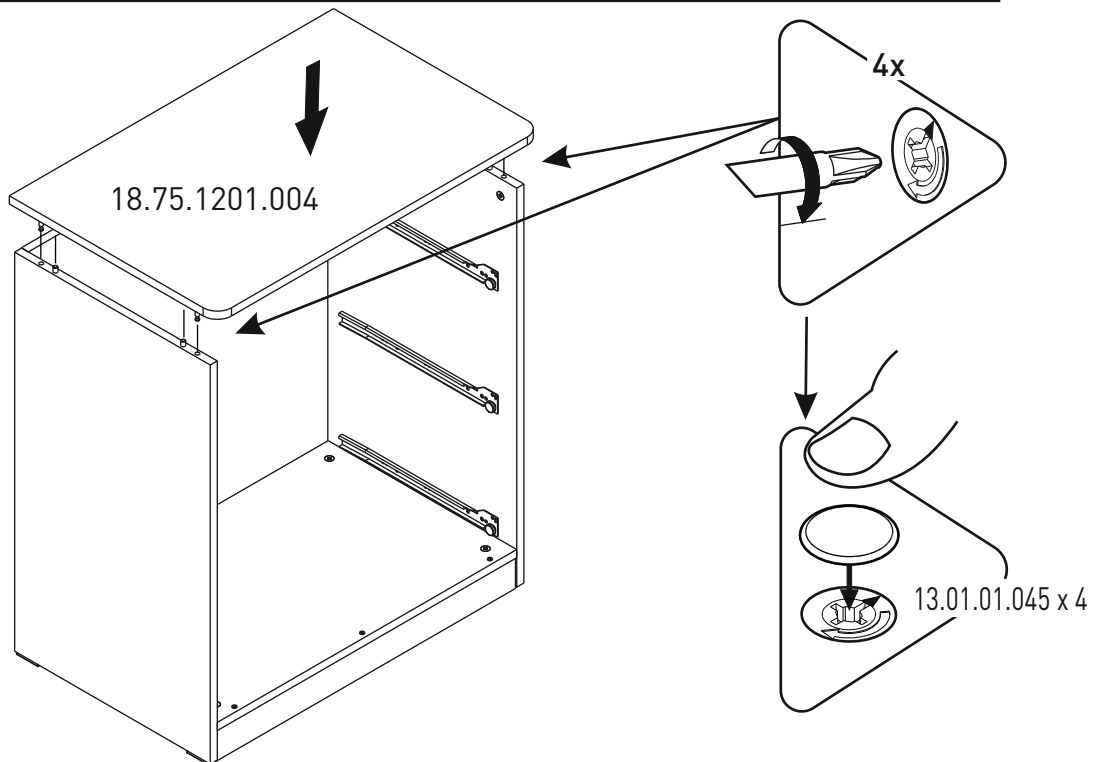

11

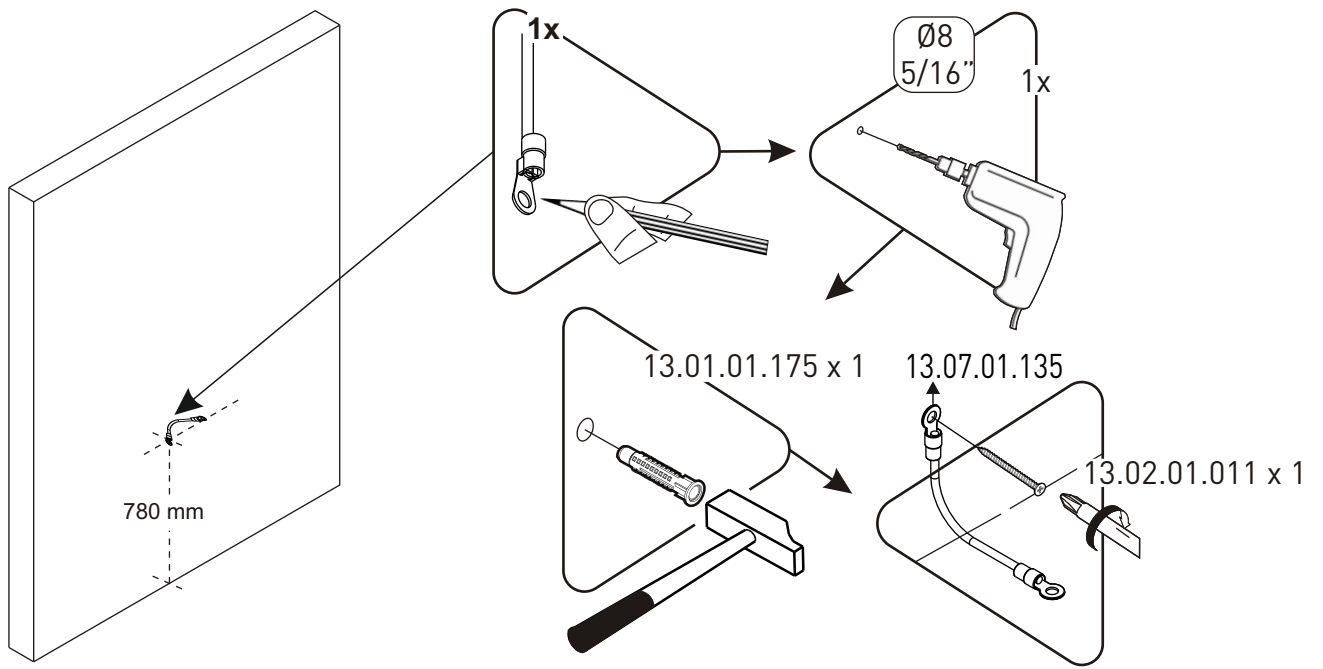

12

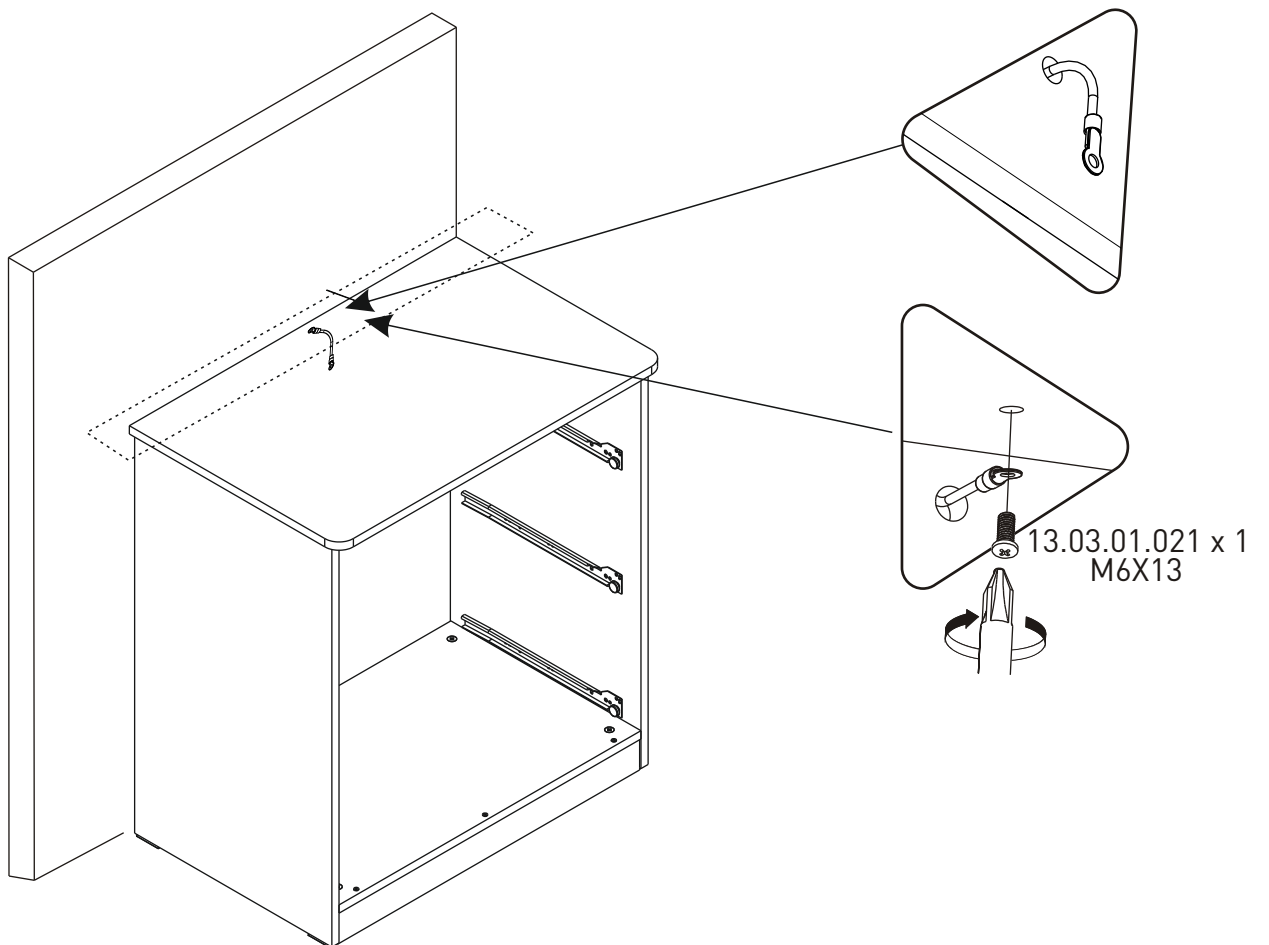

13

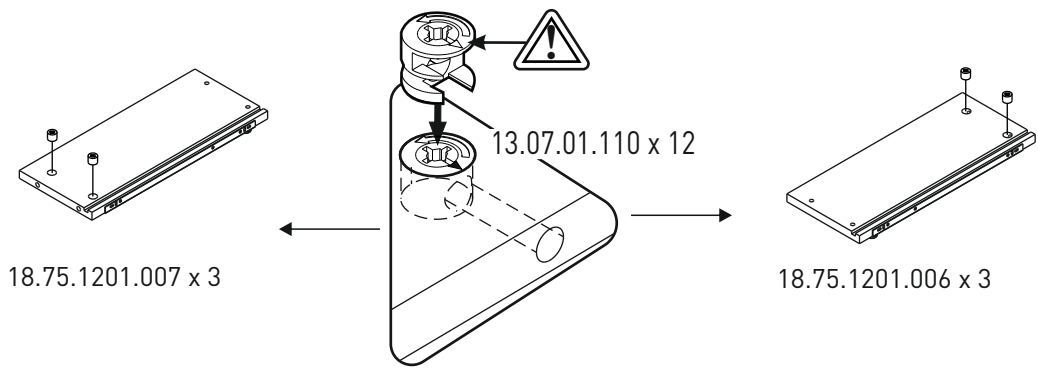

14

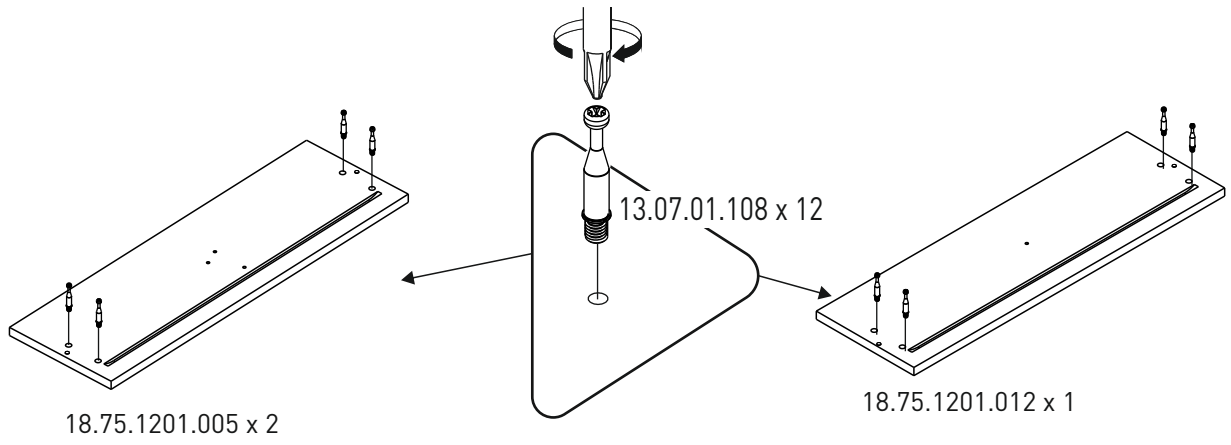

15

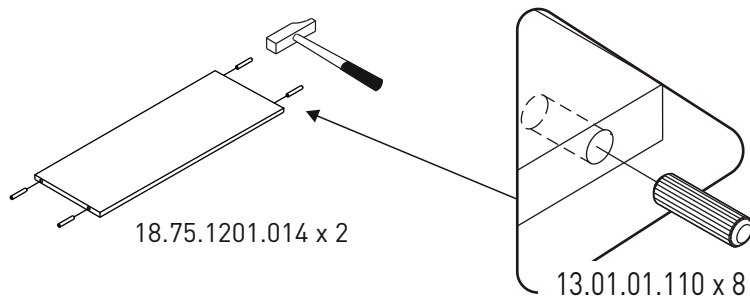

16

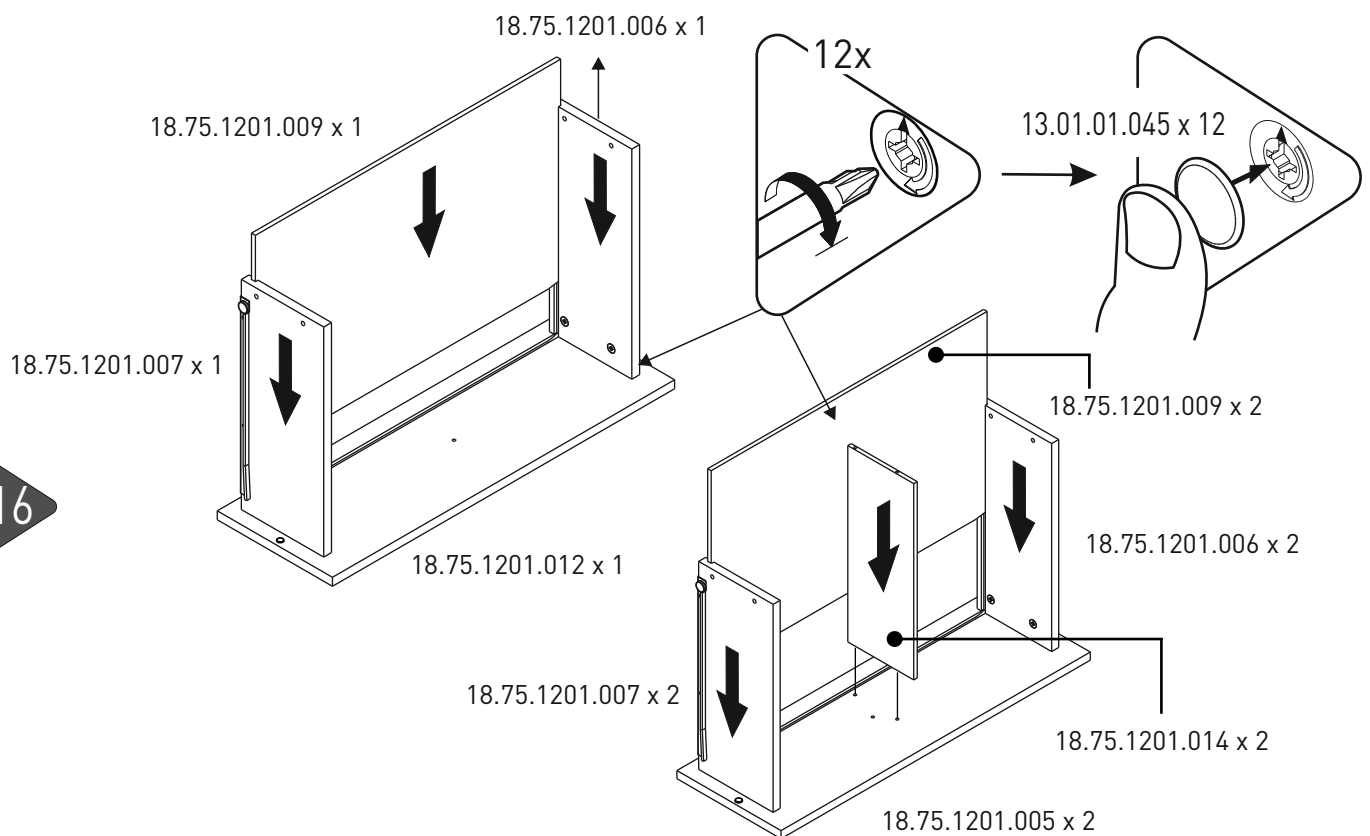

17

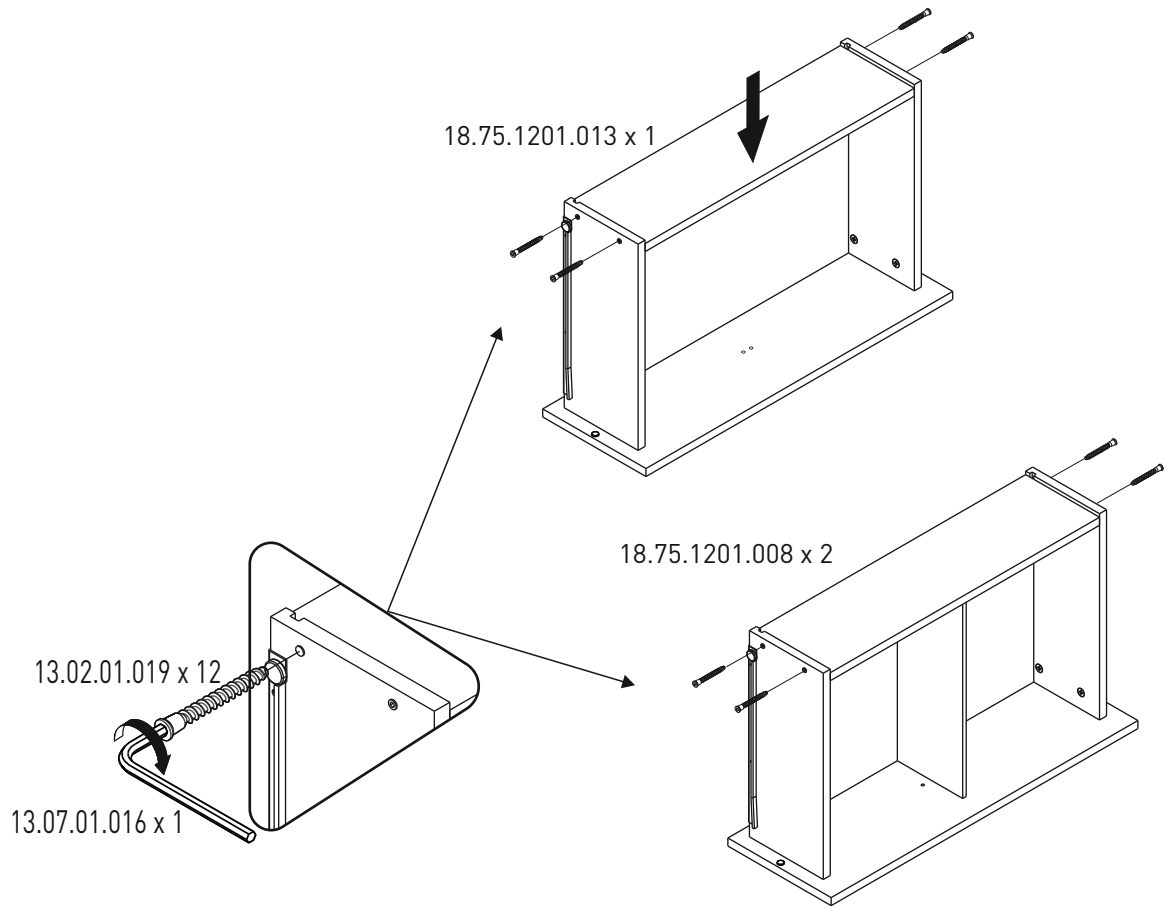

18

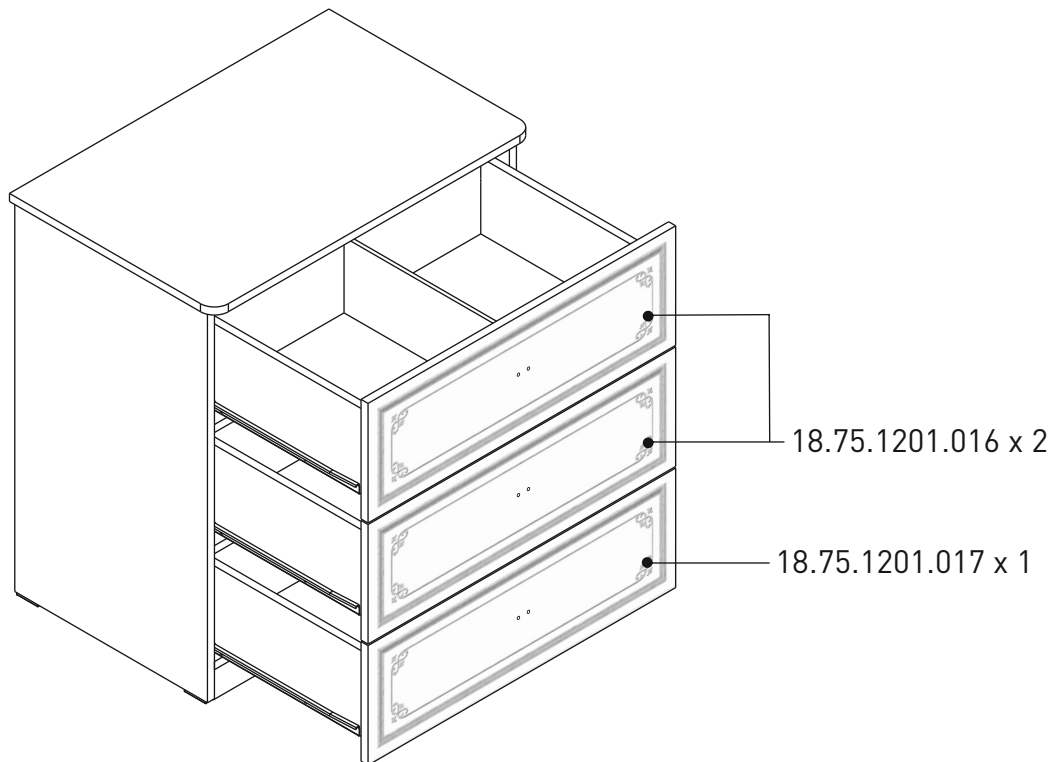

19

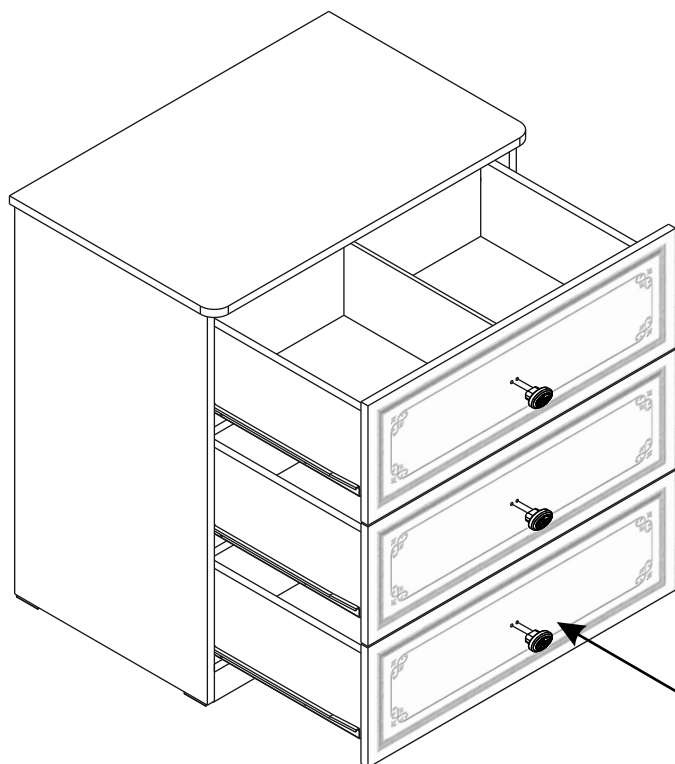

13.03.01.010 x 3
M4x22

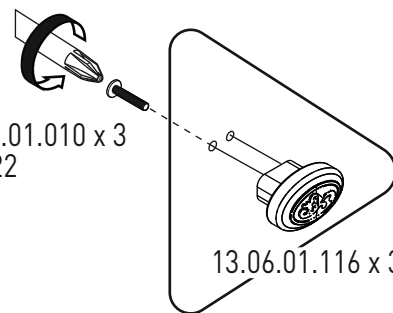

13.06.01.116 x 3

